



WURLITZER SERVICE SLANTS

YOUR QUESTIONS OR COMMENTS ON "SERVICE SLANTS"
ARE WELCOME AT ANY TIME

WURLITZER SERVICE DEPT., NORTH TONAWANDA, N. Y.

NOTE

This Service Slant supersedes Wurlitzer Service Slant W-367 in its entirety.

SUBJECT:

Modification of existing Wurlitzer Model 5134 Satellite Selective Console Speaker for use with Wurlitzer Model 3500, 200 Selection Phonographs, and Wurlitzer Model 5220-L or 5220 A-L Wall Boxes.

REASON FOR MODIFICATION:

The Model 268 Stepper and Model 5220-L and 5220 A-L Wall Boxes, used with the Model 3500, 200 Selection Phonograph, incorporate a "Lockout" circuit. This circuit prevents selections being made from a Wall Box while any other Wall Box is in its selection cycle. At completion of selection cycle, the "Lockout" circuit drops out permitting selections to be made from any other associated Wall Box. Therefore, modification of the Model 5134 Satellite Selective Console Speaker is necessary to make the Model 5134 Satellite Selective Console Speaker compatible with the Model 3500, 200 Selection Phonograph and Model 5220-L and 5220 A-L Wall Boxes.

Materials Required

- 1 - 76462-37 Capacitor, 25 Mfd., 50 V.
- 1 - 76700-20 Diode
- 1 - 75004-9 Wire, White/Red, 22 Ga.
- 1 - 73782-32 Roll Pin
- 1 - 125796 Cam
- 1 - 137884 Switch and Bracket Assembly
- 2 - 73533-35 Screw, 8-32 x 5/16 RD. SEM
- 1 - 122133 Relay, White

MODIFICATION:

To modify the existing Wurlitzer Model 5134 Satellite Selective Console Speaker perform the following:

1. Verify that the Satellite Line Switch is in OFF position.
2. Unlock and open Dome Assembly.
3. Disconnect COIN REGISTER MECHANISM PLUG from Coin Register Mechanism Socket shown in Figure 1.
4. Remove THUMB SCREW securing COIN REGISTER MECHANISM to Selector Mechanism, then remove COIN REGISTER MECHANISM. Retain THUMB SCREW for reassembly. See Figure 1.
5. Remove three screws securing Selector Mechanism to rear of Satellite cabinet, then remove Selector Mechanism. Retain screws for reassembly.
6. Remove and discard Red LOCKOUT RELAY, shown in Figure 1, from Lockout Relay Socket.
7. Remove and retain Red LP RELAY, shown in Figure 1, from LP Relay Socket.
8. Remove two screws securing RELAY MOUNTING BRACKET and WIRE ASSEMBLY, shown in Figure 1, to Selector Mechanism, then remove RELAY MOUNTING BRACKET and WIRE ASSEMBLY. Retain screws for reassembly.
9. Unsolder and disconnect White wire from Contact 13 of LOCKOUT RELAY SOCKET. Refer to Figure 2 for socket location.

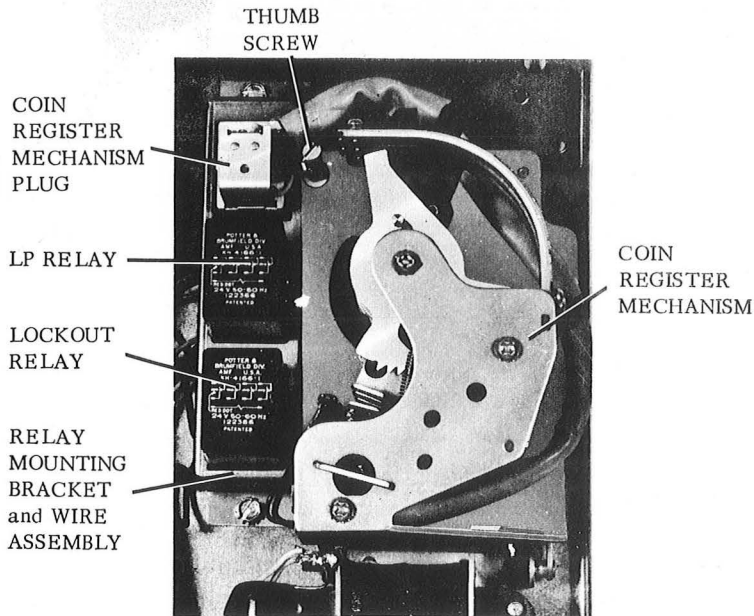

Figure 1.

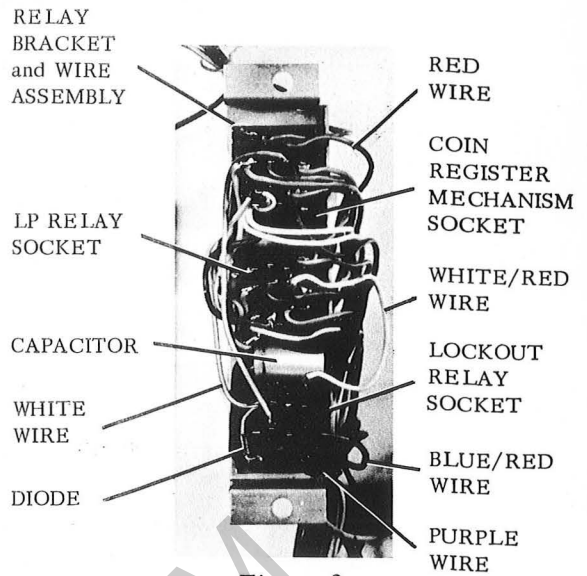

Figure 2.

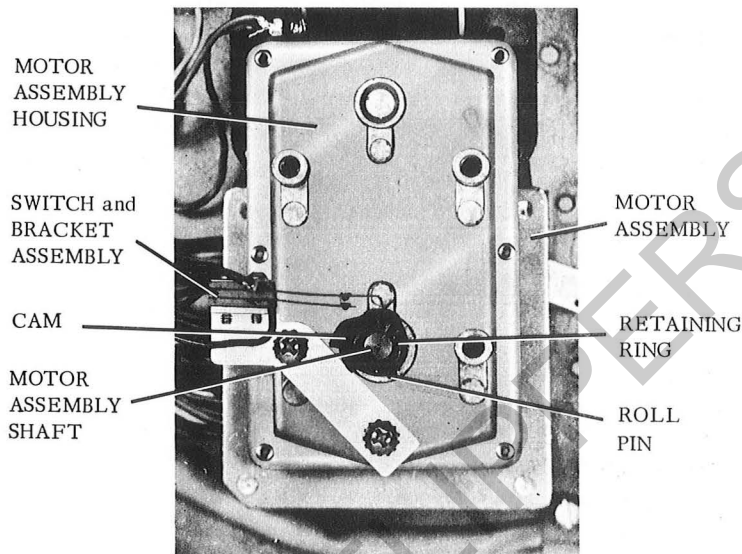

Figure 3.

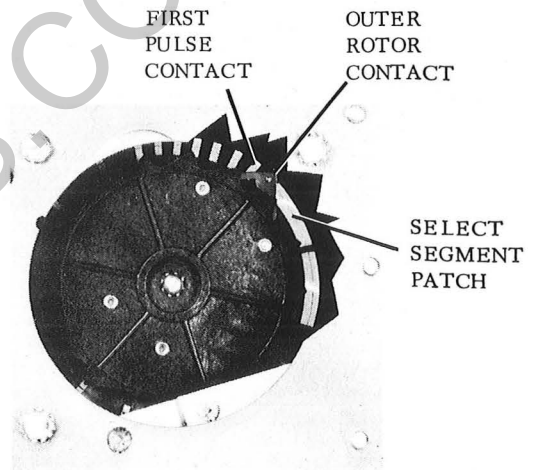

Figure 4.

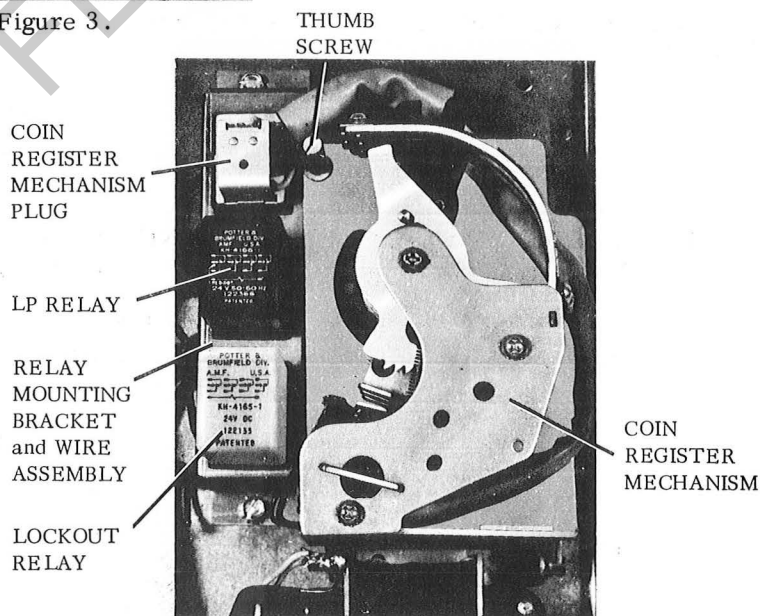

Figure 5.

10. Connect CAPACITOR, Part No. 76462-37, between Contacts 13 and 14 of LOCKOUT RELAY SOCKET (plus side of CAPACITOR to Contact 13) as shown in Figure 2. Do not solder at this time.
11. Connect DIODE, Part No. 76700-20, between Contacts 13 and 10 of LOCKOUT RELAY SOCKET (Cathode to Contact 13) as shown in Figure 2. Do not solder at this time.
12. Connect White wire, disconnected in Step 9, to Contact 10 of LOCKOUT RELAY SOCKET, as shown in Figure 2. Do not solder at this time.
13. Unsolder and disconnect the Blue/Red wire connecting the select patch to Contact 8 of LP RELAY SOCKET from Contact 8 of LP RELAY SOCKET. Refer to Figure 2. for socket location.
14. Connect Blue/Red wire, disconnected in Step 13, to Contact 12 of LOCKOUT RELAY SOCKET as shown in Figure 2. Do not solder at this time.
15. Connect three inch WHITE/RED WIRE, Part No. 75004-9, between Contact 8 of LP RELAY SOCKET and Contact 4 of LOCKOUT RELAY SOCKET as shown in Figure 2. Do not solder at this time.
16. Install ROLL PIN, Part No. 73782-32, in MOTOR ASSEMBLY SHAFT as shown in Figure 3.
17. Verify that MOTOR ASSEMBLY is in normal rest position then install CAM, Part No. 136524, on MOTOR ASSEMBLY SHAFT as shown in Figure 3.
18. Install RETAINING RING, Part No. 125797, on MOTOR ASSEMBLY SHAFT as shown in Figure 3.
19. Install and position SWITCH and BRACKET ASSEMBLY, Part No. 137884, on MOTOR ASSEMBLY HOUSING as shown in Figure 3. Secure SWITCH and BRACKET ASSEMBLY to MOTOR ASSEMBLY HOUSING with two Screws, Part No. 73533-25. Do not tighten screws at this time.
20. With V portion of switch blade resting on CAM as shown in Figure 3, adjust switch so that contacts are open .015" minimum.
21. Manually rotate CAM until V portion of Switch blade drops off CAM. Switch should close with good wiping action. Tighten screws.
22. At this point the OUTER ROTOR CONTACT should be 1/2 to 3/4 the distance from the SELECT SEGMENT PATCH to the FIRST PULSE CONTACT as shown in Figure 4. Readjust SWITCH and BRACKET ASSEMBLY as necessary to meet this requirement.
23. Connect Red wire of SWITCH and BRACKET ASSEMBLY to Contact 2 of COIN REGISTER MECHANISM SOCKET as shown in Figure 2. Do not solder at this time.
24. Connect Purple wire of SWITCH and BRACKET ASSEMBLY to Contact 14 of LOCKOUT RELAY SOCKET as shown in Figure 2.
25. Solder all connections at this time.
26. Reinstall RELAY MOUNTING BRACKET and WIRE ASSEMBLY on Selector Mechanism Assembly, as shown in Figure 4, and secure with two screws removed in Step 8.
27. Install new White LOCKOUT RELAY, Part No. 122133, in Lockout Relay Socket as shown in Figure 5.
28. Install Red LP RELAY, removed in Step 7, in LP Relay Socket as shown in Figure 5.
29. Reinstall Selector Mechanism Assembly in Satellite. Secure to rear of cabinet with three screws removed in Step 5.
30. Reinstall COIN REGISTER MECHANISM in Selector Mechanism Assembly. Secure with THUMB SCREW, removed in Step 4, as shown in Figure 5.
31. Reconnect COIN REGISTER MECHANISM PLUG in Coin Register Mechanism Socket as shown in Figure 5.

Preparation For Operation

The Satellite is equipped with a low impedance stereophonic volume control. This control will provide a moderate sound level at the Satellite provided the cable run is not over fifty feet. To operate the Satellite at a high sound level, or in installations requiring a cable run in excess of fifty feet, this control may be aided with a Kit 213 Stereo Matching Transformer Unit, Part No. 135783. Installation Instructions are packed with the kit.

Twelve conductor cable (same as used for Wurlitzer Wall Boxes) should be used to connect the Satellite to the Phonograph Accessory Terminal Panel.

If Wall Boxes are to be used, DO NOT connect Wall Boxes to the Satellite cable. Separate cables must be used for the Satellite and the Wall Boxes. A Maximum of three Wall Boxes may be connected to the Phonograph Accessory Terminal Panel in parallel with the Satellite.

Connect the cable from the Satellite to the WALL BOX Terminal Strip, located on the Phonograph Accessory Terminal Panel, as follows:

NOTE

DO NOT connect the Blue and Violet wires from the Satellite cable to the Phonograph WALL BOX Terminals. Due to audio considerations, these wires from Terminals 6 and 7 of the Satellite must be connected to the EXTERNAL SPEAKERS Low Impedance Terminal Strip (located on the Phonograph Accessory Terminal Panel) in accordance with the limitations set forth on Page 5 G of the Model 3500 Series Service Manual. The Satellite speakers should be considered as one 16 ohm speaker per channel as are the Phonograph speakers.

Satellite Terminal No.	to	Phonograph WALL BOX Terminal No.	Wire Color	Wire Gauge	Function
1	to	1	Grey	20	Pulse
G	to	G	White	16	Ground
2	to	8	Orange	22	Lockout Circuit
3	to	3	Black	16	24 Volts A.C.
4	to	4	Yellow	22	Speaker Ground
5	to	5	Green	22	Audio Relay Ground
6	See NOTE above.		Blue	22	Channel "B" Audio
7			Violet	22	Channel "A" Audio
9	to	9	Pink	22	10 Cents
10	to	10	Tan	22	25 Cents
11	to	11	Brown	22	50 Cents

Tape and stow both ends of Red wire.

NOTE

The Pink, Tan and Brown wires from Terminals 9, 10, and 11 are for Income Computer operation only. However, connecting these wires as outlined above will in no way affect the operation of the Satellite/Phonograph. If an Income Computer has not been installed in the Phonograph, these wires may be taped and stowed.

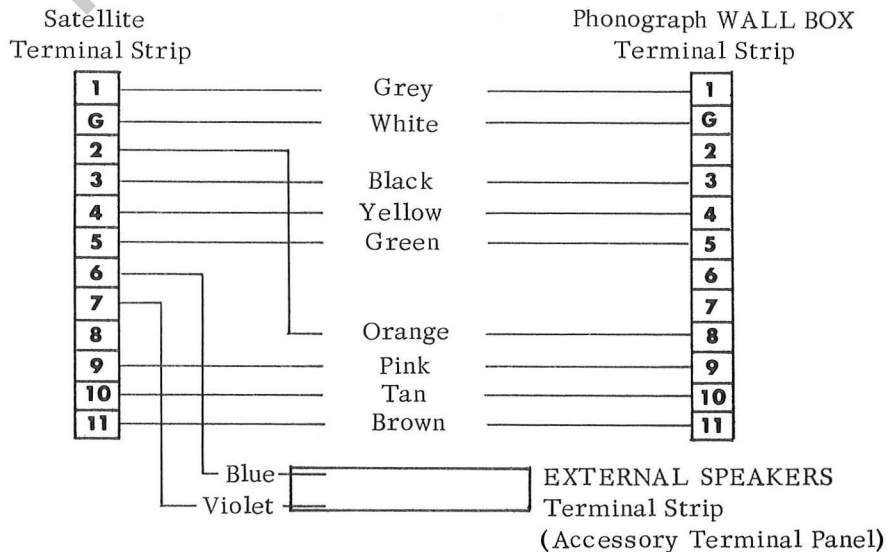

Pricing

The standard factory setting of the Satellite is as follows:

- 2 credits for a quarter
- 5 credits for a half dollar or two consecutive quarters.

	Playrak Stop Lever Position	
	25¢	50¢
Quarter		
2 Singles or 1 LP	2	
Half Dollar or 2 Consecutive Quarters		
5 Singles or 2 LP		5
1 LP + 2 Singles		

A single selection may be made upon establishment of one or more credits. An album selection may be made upon establishment of 2 or more credits.

One credit will be cancelled when a single selection is made. Three credits will be cancelled when an LP selection is made.

Optional Pricing

Pricing may be easily changed to other combinations. For example, to change pricing from factory setting to one credit for a dime or two nickels, three credits for a quarter, and seven credits for a half dollar or two consecutive quarters, proceed as follows:

- A. Verify that the Satellite line switch is in the OFF position.
- B. Remove the coin register mechanism from the Satellite.
- C. Reposition the 10¢, 25¢, and 50¢ stop levers to the 1, 3 and 7 credit positions.
- D. Establish three credits by manually actuating the 25¢ Lever, Hub and Stud Assembly.
- E. Loosen the LP CONTROL SWITCH ADJUSTING SCREW and reposition the LP CONTROL SWITCH to close with good wiping action.
- F. Manually cancel off one credit. The LP CONTROL SWITCH must open with .025" clearance between contacts. Tighten the LP CONTROL SWITCH ADJUSTING SCREW.
- G. Reinstall the coin register mechanism in the Satellite.
- H. Remove the nickel and dime return wire from the slug rejector.
- I. Replace the standard coin denomination and instruction label with the appropriate label found in the Satellite cash bag.

The Satellite pricing will now be as follows:

- 1 credit for a dime or two nickels
- 3 credits for a quarter
- 7 credits for a half dollar or two consecutive quarters.

	Playrak Stop Lever Position		
	10 ¢	25¢	50¢
Dime or Two Nickels			
1 Single	1		
Quarter			
3 Singles or 1 LP		3	
Half Dollar or 2 Consecutive Quarters			
7 Singles or 2 LP + 1 Single			7
1 LP + 4 Singles			

LP Programming

Satellites are shipped from the factory with A and B selections set for LP Album play. All other selections are singles.

Various combinations of LP Album and single selection programming may be obtained by changing the position of the LP Conversion Switches located on the Phonograph Selector Switch Assembly. These switches are identified as to the selections each control. In the "ON" position the specified selections are LP's; in the "OFF" position - singles.

COMPUTER OPERATION

Coins deposited in the Satellite will register on the Model 233 Income Computer, Part No. 137214, provided the Phonograph is so equipped.

SELECTOR SWITCH ASSEMBLY ADJUSTMENTS

See Wurlitzer 3500 Series Phonograph Service Manual.

SELECTOR MECHANISM ADJUSTMENTS

See Wurlitzer 5220 Series Wall Box Service Manual.

WIRING DIAGRAM - MODEL 5134 - SATELLITE II

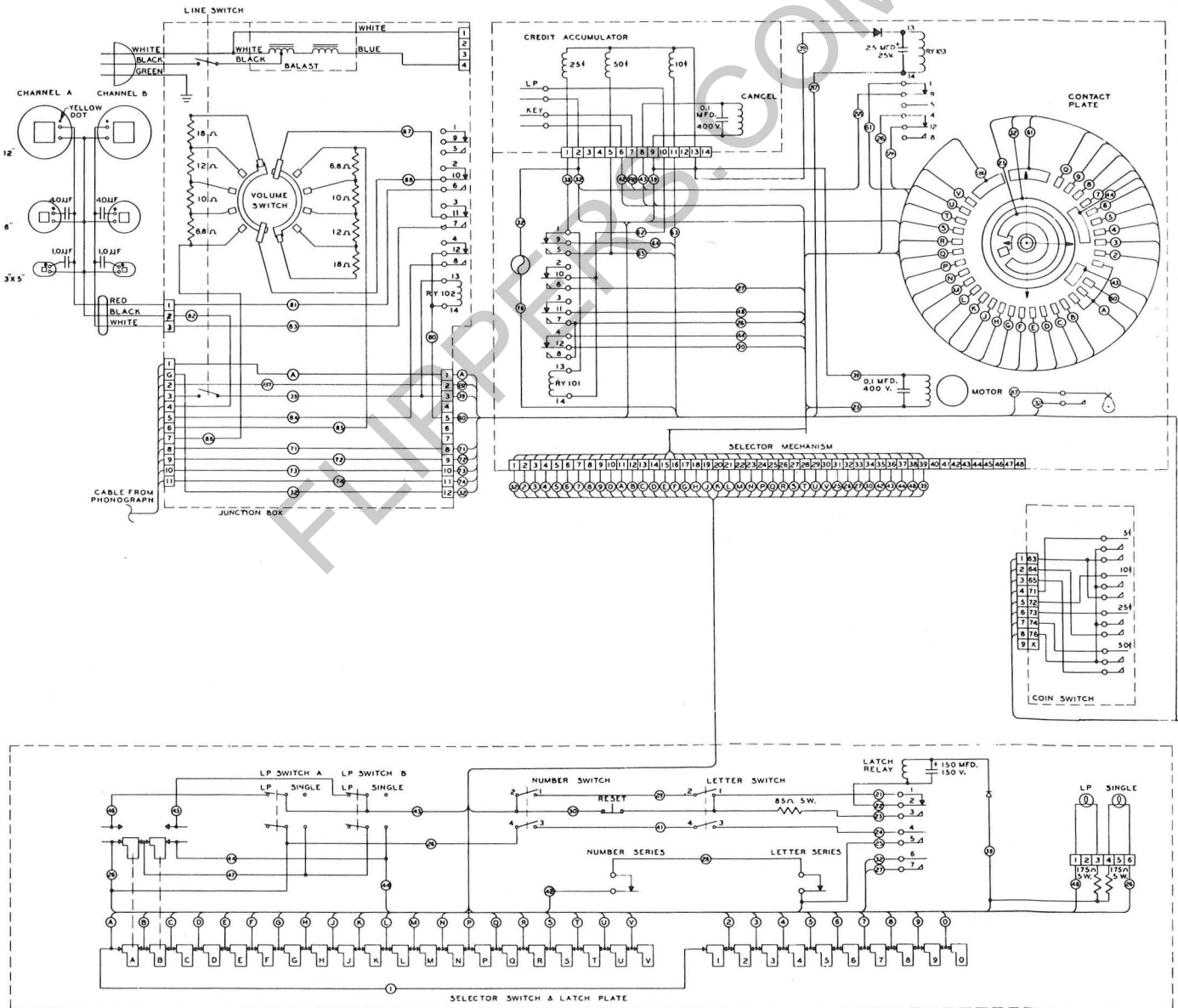

Pricing

The standard factory setting of the Satellite is as follows:

- 2 credits for a quarter
- 5 credits for a half dollar or two consecutive quarters.

	Playrak Stop Lever Position	
	25¢	50¢
Quarter		
2 Singles or 1 LP	2	
Half Dollar or 2 Consecutive Quarters		
5 Singles or 2 LP		5
1 LP + 2 Singles		

A single selection may be made upon establishment of one or more credits. An album selection may be made upon establishment of 2 or more credits.

One credit will be cancelled when a single selection is made. Three credits will be cancelled when an LP selection is made.

Optional Pricing

Pricing may be easily changed to other combinations. For example, to change pricing from factory setting to one credit for a dime or two nickels, three credits for a quarter, and seven credits for a half dollar or two consecutive quarters, proceed as follows:

- A. Verify that the Satellite line switch is in the OFF position.
- B. Remove the coin register mechanism from the Satellite.
- C. Reposition the 10¢, 25¢, and 50¢ stop levers to the 1, 3 and 7 credit positions.
- D. Establish three credits by manually actuating the 25¢ Lever, Hub and Stud Assembly.
- E. Loosen the LP CONTROL SWITCH ADJUSTING SCREW and reposition the LP CONTROL SWITCH to close with good wiping action.
- F. Manually cancel off one credit. The LP CONTROL SWITCH must open with .025" clearance between contacts. Tighten the LP CONTROL SWITCH ADJUSTING SCREW.
- G. Reinstall the coin register mechanism in the Satellite.
- H. Remove the nickel and dime return wire from the slug rejector.
- I. Replace the standard coin denomination and instruction label with the appropriate label found in the Satellite cash bag.

The Satellite pricing will now be as follows:

- 1 credit for a dime or two nickels
- 3 credits for a quarter
- 7 credits for a half dollar or two consecutive quarters.

	Playrak Stop Lever Position		
	10 ¢	25¢	50¢
Dime or Two Nickels			
1 Single	1		
Quarter			
3 Singles or 1 LP		3	
Half Dollar or 2 Consecutive Quarters			
7 Singles or 2 LP + 1 Single			7
1 LP + 4 Singles			

LP Programming

Satellites are shipped from the factory with A and B selections set for LP Album play. All other selections are singles.

Various combinations of LP Album and single selection programming may be obtained by changing the position of the LP Conversion Switches located on the Phonograph Selector Switch Assembly. These switches are identified as to the selections each control. In the "ON" position the specified selections are LP's; in the "OFF" position - singles.

COMPUTER OPERATION

Coins deposited in the Satellite will register on the Model 233 Income Computer, Part No. 137214, provided the Phonograph is so equipped.

SELECTOR SWITCH ASSEMBLY ADJUSTMENTS

See Wurlitzer 3500 Series Phonograph Service Manual.

SELECTOR MECHANISM ADJUSTMENTS

See Wurlitzer 5220 Series Wall Box Service Manual.

WIRING DIAGRAM - MODEL 5134 - SATELLITE II

